



IJETMR

# International Journal of Engineering Technologies and Management Research

A Knowledge Repository



## DESIGN AND SIMULATION OF DIELECTRIC RESONATOR ANTENNA (DRA) WITH CO-AXIAL PROBE FOR WIRELESS APPLICATION

Devansh Sinha<sup>1</sup>, Mohit Vyas<sup>2</sup>, Sanjay Singh Kushwah<sup>3</sup>

<sup>1</sup> Assistant Professor, ECE Department, GEC College, Gwalior (M.P.), India

<sup>2</sup> Assistant Professor, ECE Department, Amity University, Gwalior (M.P.), India

<sup>3</sup> Professor, ECE Department, GEC College, Gwalior (M.P.), India



### Abstract:

*In this paper a Dielectric resonator antenna (DRA) consists of a rectangular geometry and a printed rectangular patch on top of it in order to achieve better performance and operation without significant increase in antenna size. DRA structure is proposed at a height of 2 mm from the ground plane and patch incorporated at the height of 3.638 mm. This work is mainly focused on increasing the potential parameters of DRA and analyze high frequency band. The proposed antenna is designed to resonate at 25 GHz and by varying the DRA size 'a', then the simulated results shows variation in Return Loss. The impedance bandwidth of the DRA (23.417 GHz-26.961 GHz) and return loss is 26.543951dB. The proposed DRA is analyzed and design using CST-MSW (2010). The simulated result shows the Far field, smith chart. We have estimated the wavelength, frequency, bandwidth, Return loss and directivity.*

**Keywords:** Dielectric Resonator Antenna; Wireless Application; Co-Axial.

**Cite This Article:** Devansh Sinha, Mohit Vyas, and Sanjay Singh Kushwah. (2018). "DESIGN AND SIMULATION OF DIELECTRIC RESONATOR ANTENNA (DRA) WITH CO-AXIAL PROBE FOR WIRELESS APPLICATION." *International Journal of Engineering Technologies and Management Research*, 5(2:SE), 75-83. DOI: <https://doi.org/10.29121/ijetmr.v5.i2.2018.616>.

## 1. Introduction

Dielectric resonators have established great interest in current years for their latent applications in microwave and millimeter wave communication systems. They have been extensively used as a tuning component in shielded microwave circuits such as filters, oscillators, and cavity resonators. With an suitable feed arrangement, they can also be used as antennas, and they offer efficient radiation [1]. Also micro strip antenna at higher microwave band applications such as satellite communication and radar application usually offers high metallic losses. So, the DRA can be a good alternative for these requirements as it overcomes the problem of high losses due to minimum surface wave losses. DRA generally made up of temperature stable dielectric materials of high dielectric constants (10-100) for microwave applications. Resonant frequency of DRA can be easily varied by suitably choosing the dielectric constant of the resonator material and its dimensions [2]. DRAs of different shapes such as disc, hemispherical, rectangular, and ring have been presented in the literature [3],[2],[4],[5]. The rectangular dielectric resonators are preferred because they are easy to fabricate and offer more degree of freedom to control the

resonant frequency and quality factor. Many investigations have been conducted to enhance bandwidth and gain of DRA [6],[4],[7],[8] but front to back ratio (FBR) of DRA has not been presented so far. Micro strip fed DRA act as a magnetic dipole and suffers with problem of back lobe. So in this paper reflector plane is used to improve the FBR.

## 2. Dra Structure With Co-Axial Probe

When a dielectric resonator is not entirely enclosed by a conductive boundary, it can radiate, and so it becomes an antenna. Figure 1.1 shows the geometry of the proposed rectangular DRA ( $\epsilon_r=11.9$ ) with size of  $a*a*h$ . A printed patch antenna with size of  $b*b$  on a substrate ( $\epsilon_r=2.2$ ) is placed on the top of the dielectric resonator. The DRA is fed using a coaxial probe, with a distance  $x_0$  from the center of the DRA. The height of the feed probe above the ground plane is  $l$ . By optimizing the structure parameters, the DRA and the patch antenna can resonate at two different frequencies. The rectangular dielectric resonator provides the first resonance frequency  $f_1$  while the patch antenna resonates at the second frequency  $f_2$ . In addition, this way of attaching the DRA presented the advantage of allowing a convenient reuse of the same feeding circuit with various dielectric resonators.

Where 'a' is the length and breadth of the DRA, 'a'= 2.5mm

Where 'h' is the height of DRA, h=2.0mm and 'b' is the length and breadth of the patch, b= 2.0mm.

The feed position is  $x_0$  distance away from the centre of x-axis. The probe is inserted up to 'l' distance in DRA. Top-view of proposed DRA is shown in Figure 1.2 and the view of port and probe in DRA is shown in Figure 1.3.

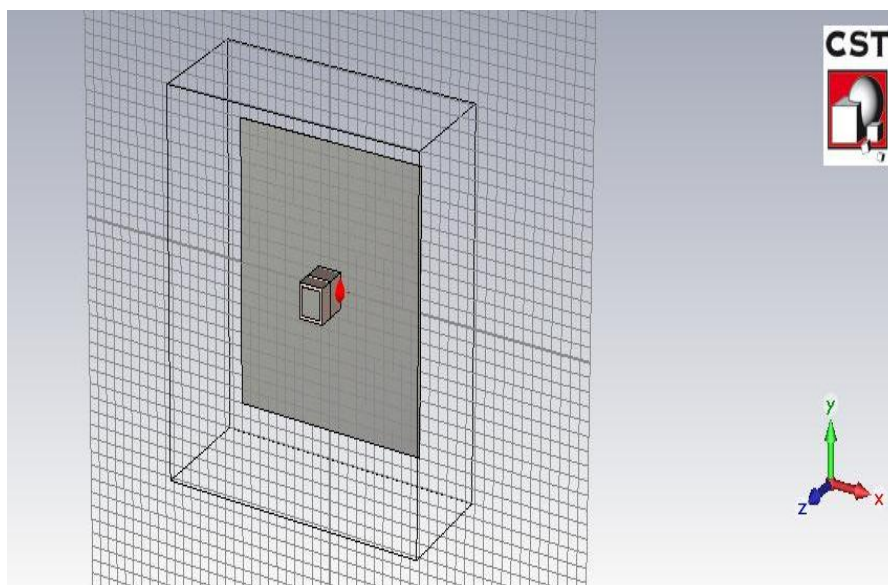

Figure 1.1: Geometry of Proposed DRA with co-axial probe

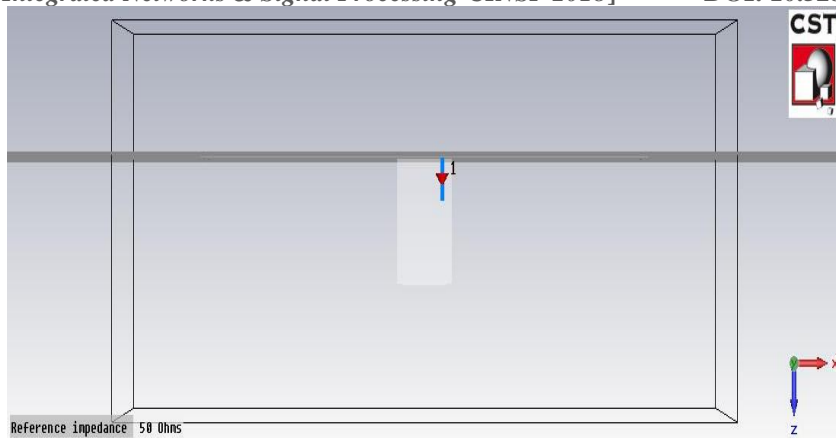

Figure 1.2: opview of Proposed DRA

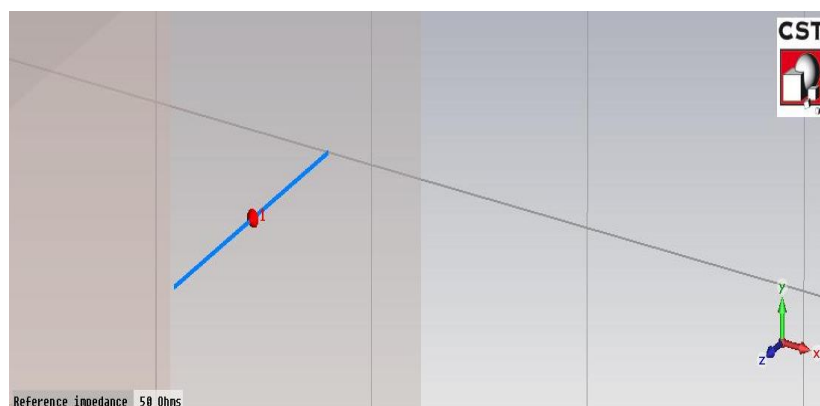

Figure 1.3: Shows the view of Port and Probe in Proposed DRA

### 3. Design Parameters of DRA Structure

We have estimated the Bandwidth, Return loss, Frequency, Directivity, Wavelength and Radiation efficiency.

- 1) **Directivity** -: The directivity is defined based on the total power radiated by the antenna of interest.
- 2) **Bandwidth** -: Bandwidth of an antenna is the range of frequency within which its performance of certain characteristics conforms to a specified criterion. Such antenna characteristics may be input impedance, radiation pattern, beam width, polarization, side lobe level, gain, beam direction, and so on. The bandwidth is usually expressed as the ratio between the upper and lower frequencies with acceptable performance. The frequency slot is shown in Figure 1.5.
- 3) **Return Loss** -: Measured and simulated Return Loss of the DRA is shown in fig1.4.
- 4) **Frequency** -: Frequency is the number of occurrences of a repeating event per unit time. It is also referred to as temporal frequency. The period is the duration of one cycle in a repeating event, so the period is the reciprocal of the frequency
- 5) **Far-field** -: In the reactive near-field region, at close proximity to the antenna, reactive field predominates. In the far-field (Fraunhofer) region, roughly at  $r > 2d^2/\lambda$  with  $d$  the scale size of antenna, angular field distribution is essentially independent of the distance

from the antenna. The far-field is shown in Figure 6. In the far-field region, the dominant electric field components usually lie in a plane passing through the antenna. The far-field thus includes radio waves and microwaves several wavelengths from most types of antennas, as well as all the shorter-wave EM radiation in the electromagnetic spectrum (infrared, light, UV, X-rays, etc.).

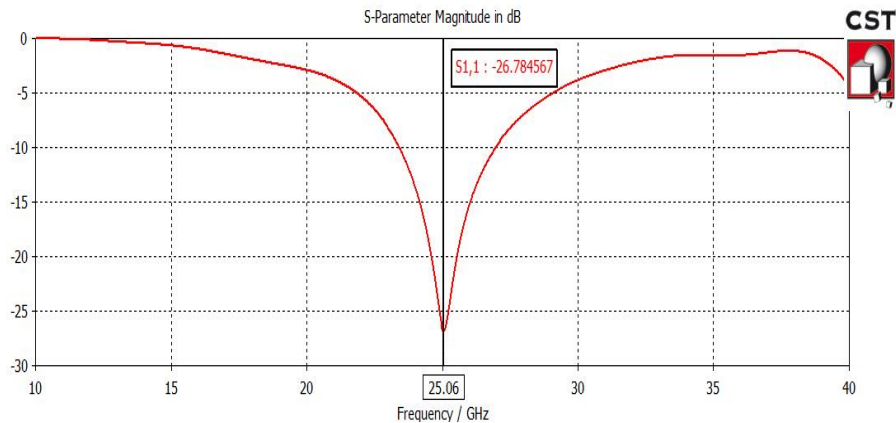

Figure 1.4: Simulated result of Return loss of Proposed DRA

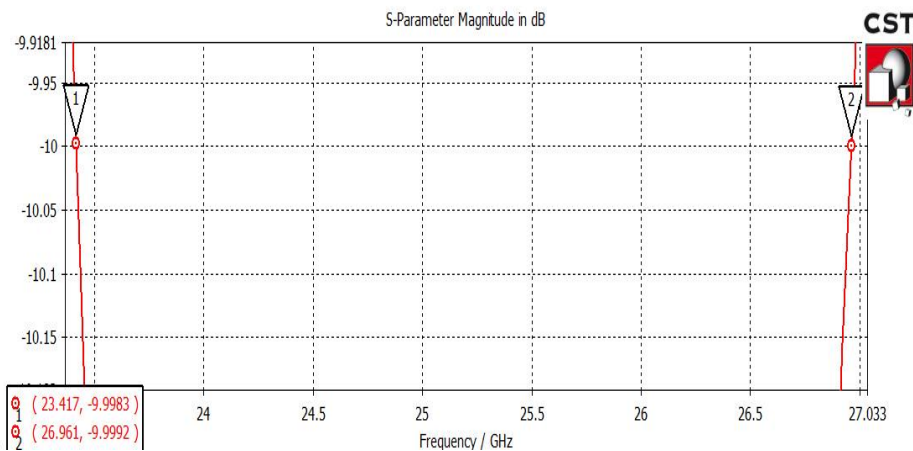

Figure 1.5: Shows Frequency slot

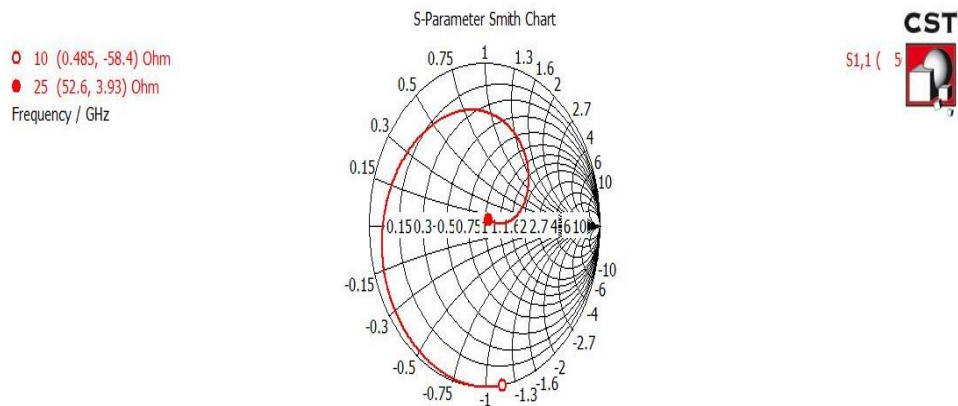

Figure 1.6: Smith Chart

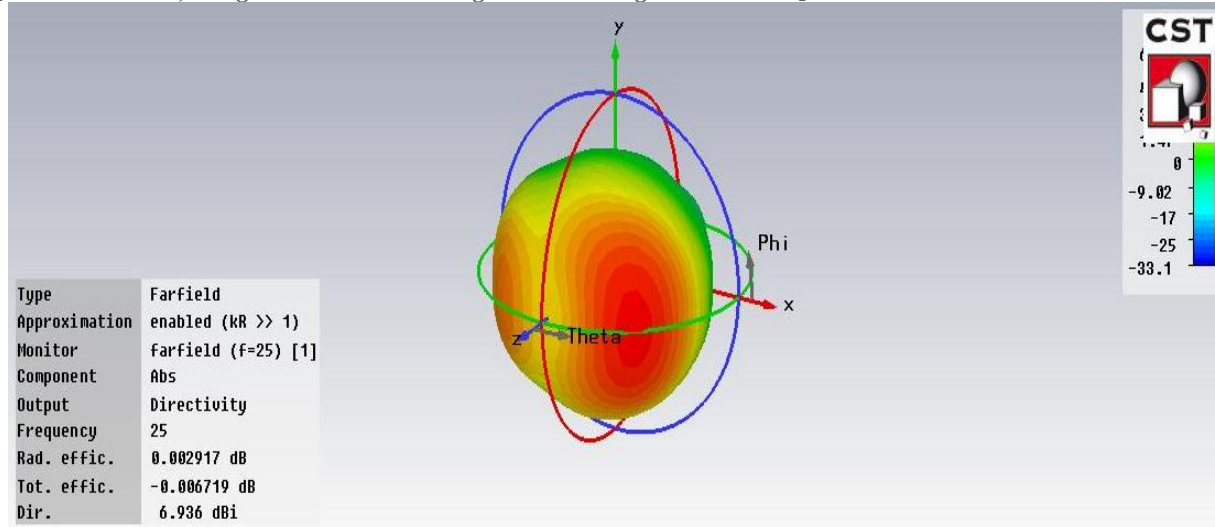

Figure 1.7: Farfield

#### 4. Varying Dra Sizes

The DRA is investigated first by varying DRA length and breadth and its simulated result is shown in respective figure. Simulated results are based on Return Loss at different frequencies. By varying size of DRA i.e., ‘a’, we calculated improved Return Losses which covers frequency. We have estimated different Return Loss at different value of ‘a. The simulated waveform is shown in Figure 1.8 we have take a =1.9mm the Return loss is -31.059 at Frequency 33.31 GHz.

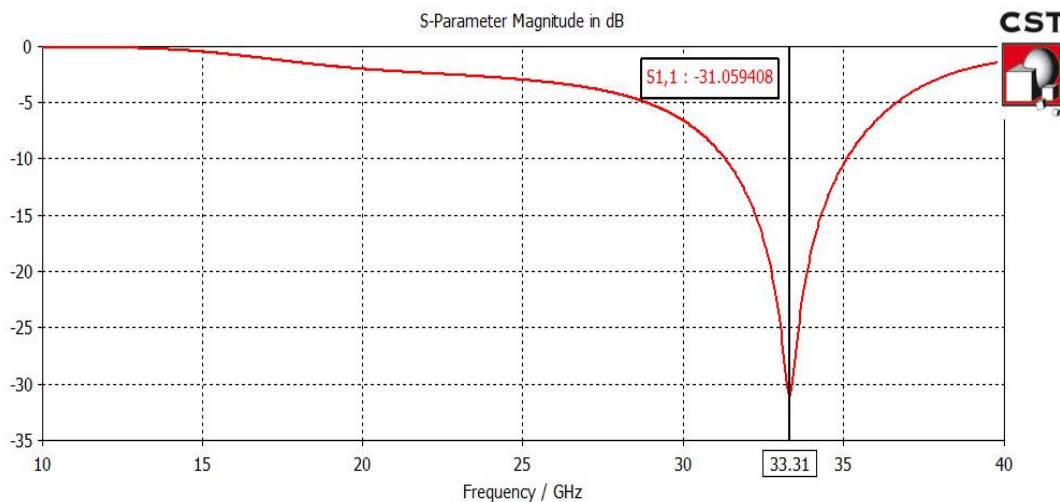

Figure 1.8: Simulated result of Return Loss

The simulated waveform is shown in Figure 1.9 we have take a=2.0mm the Return loss is -33.4916 at Frequency 31.75 GHz.

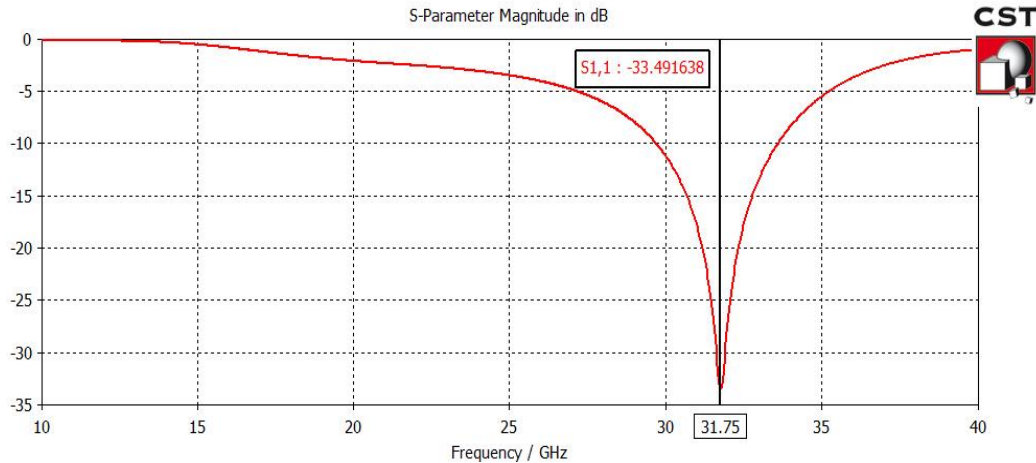

Figure 3.9: Simulated result of Return Loss

The simulated waveform is shown in Figure 1.10 we have take  $a=2.1\text{mm}$  the Return loss is -30.538439 at Frequency 30.25 GHz.

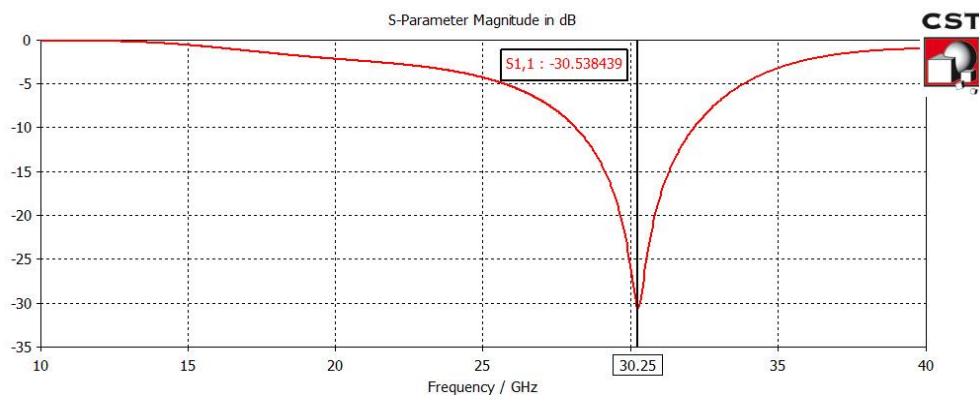

Figure 1.10: Simulated result of Return Loss

The simulated waveform is shown in Figure 1.11 we have take  $a=2.2\text{mm}$  the Return loss is -28.718102 at Frequency 28.81 GHz.

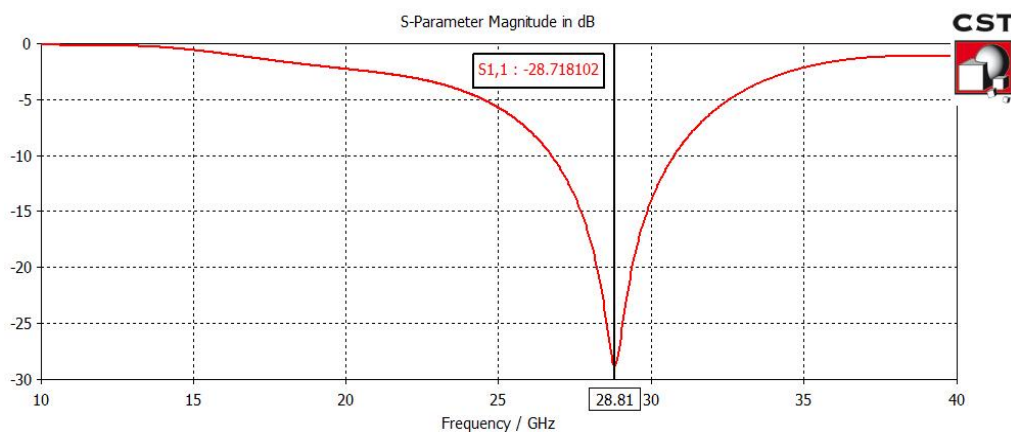

Figure 1.11: Simulated result of Return Loss

The simulated waveform is shown in Figure 1.12 we have take  $a=2.3\text{mm}$  the Return loss is -27.823662 at Frequency 27.43 GHz.

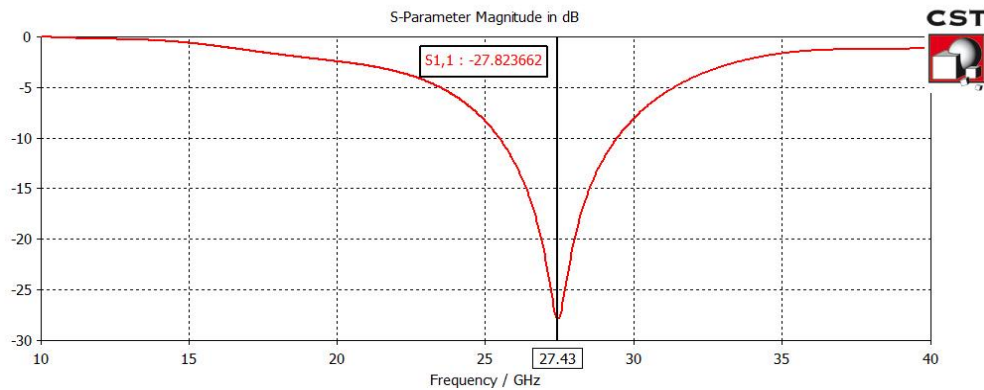

Figure 1.12: Simulated result of Return Loss

The simulated waveform is shown in Figure 1.13 we have take  $a=2.8\text{mm}$  the Return loss is -23.488611 at Frequency 22.39 GHz.

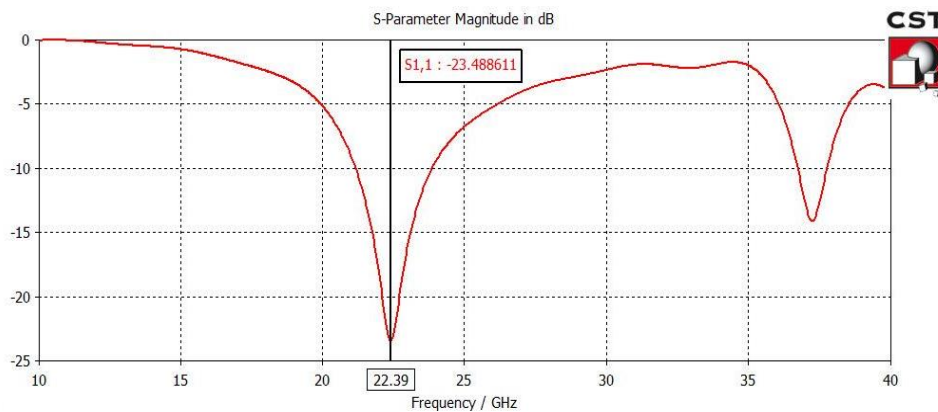

Figure 1.13: Simulated result of Return Loss

The simulated waveform is shown in Figure 1.14 we have plotted the graph at different values of 'a' and the combined Return Loss graph is shown in Figure 1.14.

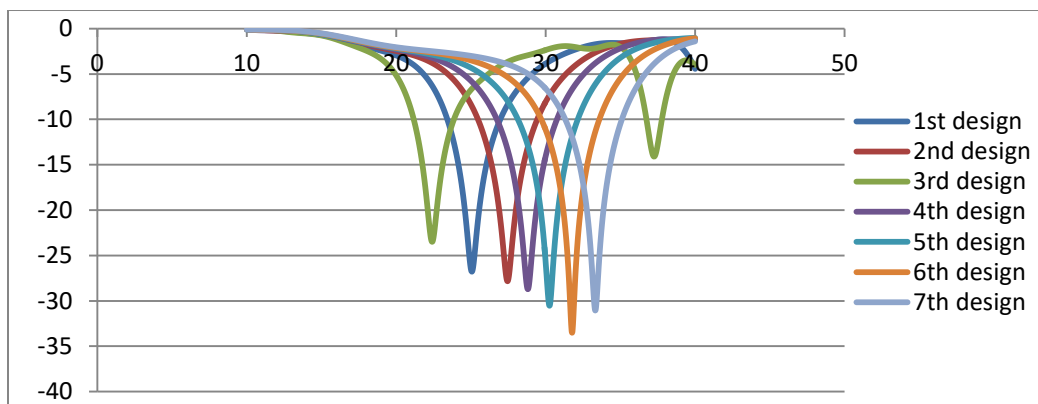

Figure 1.14: Graph of Return Loss at different value of 'a'

## 5. Simulation Result

To evaluate the parameters of DRA i.e., Directivity, Bandwidth, Wavelength and Return loss, Radiation Efficiency and Frequency which is shown in TABLE 1. Simulation result is calculated by CST-MSW.

S.no.	Parameters	Results
1.	Frequency band	10-40 GHz
2.	Frequency	25GHz
3.	Return Loss	-26.543951 Db
4.	Bandwidth	3.544GHz
5.	Wavelength	8.09mm
6.	Radiation Efficiency	0.002917 dB
7.	Directivity	6.936 dBi

## 6. Conclusion

In DRA which is composed of a probe-fed rectangular dielectric resonator and a rectangular patch antenna on top of it. We have experimentally investigated the device performance and parameters such as Return Loss, Bandwidth, Wavelength, Directivity and Radiation Efficiency. Such a hybrid antenna with compact size can provide sufficient impedance band- width and improved Return Loss and much improved Bandwidth across the desired frequency bands, which are very attractive for WLAN applications. In addition, this way of attaching the DR presented the advantage of allowing a expedient reuse of the same feeding circuit with various dielectric resonators. In comparison with micros trip radiating elements, DRA radiators have better radiation efficiency and operate over wider bandwidths. An outstanding property of DRA is their intrinsically low loss. At microwave frequencies, the losses due to the skin effect on micro strip antennas may become significant. In distinguish, there are no conductors present on DRA, and the dielectric losses are much smaller than conductor losses.

## References

- [1] Batra, D., Sharma,S., and Kohli, A. K., "Dual-Band Dielectric Resonator Antenna for C and X Band Application" International Journal of Antennas and Propagation, Vol. 12, Article ID 914201, 7 pages,2012.
- [2] Rashidian, A., and Klymyshyn, D. M., "On the two segmented and high aspect ratio rectangular dielectric resonator antennas for bandwidth enhancement and miniaturization," IEEE Transactions On Antennas And Propagation, Vol. 57, no. 9, pp. 2775-2780, 2009.
- [3] Hadalgi, P. M., et al., "Slot fed wideband dielectric resonator for wireless application," Indian Journal of Radio & Space Physics, Vol. 39, pp.372-375, 2010.
- [4] Sheng, X. Q., et al., "Analysis of waveguide-fed dielectric resonator antenna using a hybrid finite element method," IEE proc. Microwave Antenna Propagation, Vol. 151, no. 1,pp. 91-95, 2004.
- [5] Srivastava, K. V., et al, "A Modified Ring Dielectric Resonator With Improved Mode Separation In MIC Environment", 34th European Microwave Conference - Amsterdam, pp. 609-612, 2004.
- [6] Buerkle, A.,et al., "Compact slot and dielectric resonator antenna with dual resonance, broadband characteristics," IEEE trans. On Antennas and Propagation, Vol.4, pp. 1020-1024, 2005.



- [7] Kishk, A. A., “Numerical analysis of stacked dielectric resonator antennas excited by a coaxial probe for wideband applications”, IEEE Trans. On Antennas and propagation, Vol. 51, no.8, pp. 1996-2006, 2003.
- [8] Luk, K. M., Leung, K. W., and Chow, K. Y., “Bandwidth and gain enhancement of a dielectric resonator antenna with the use of a stacking element,” Microw. Opt. Technol. Lett., Vol. 14, no. 4, pp. 215–217, 1997.

---

\*Corresponding author.

E-mail address: devansh.sinha10@ gmail.com/mohitvyas542@ gmail.com/sanjaykushwah15@ gmail.com